

Linear

# MOMO RGB Fixture Guide

# KKDC

Indoor/Outdoor | Surface | RGB output

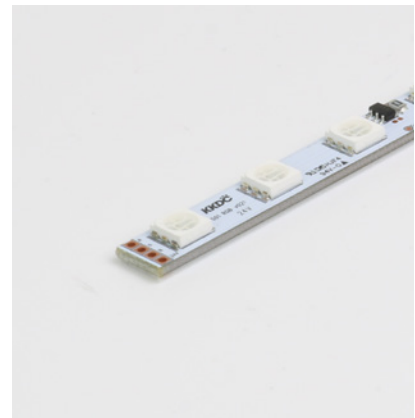

## Key applications

- ✓ Architectural detail
- ✓ Backlighting & signage
- ✓ Bathrooms
- ✓ Building façades
- ✓ Cove lighting
- ✓ Direct lighting
- ✓ Exterior
- ✓ Interior
- ✓ Mirror back lighting
- ✓ Pathways/driveways
- ✓ Public spaces
- ✓ Special effect
- ✓ Wall grazing
- ✓ Window reveal
- ✓ Wet area

## Key features

- ✓ Adjustable
- ✓ Custom lengths
- ✓ Constant Voltage (CV)
- ✓ Diffusion: homogenous
- ✓ Direct view
- ✓ Glare control options
- ✓ IP44 moisture resistant
- ✓ IP67 waterproof
- ✓ Lens options
- ✓ Nano louvre
- ✓ RGB

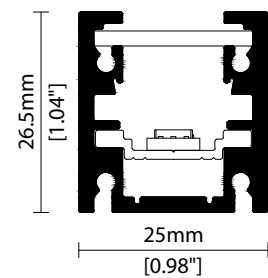

C - Diffused Cover

## MOUNTING METHODS

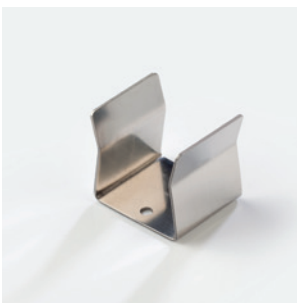

KKCP-03 Clip



KKCP-09 Lock clip



KKBK-07 Fixing plate



KKBK-21 Adjustable bracket

Linear

# MOMO RGB

## Specification sheet



<b>Dimensions</b>	H28/W22/L94-2011mm (H1.1/W0.87/L3.70-79.17in) *Nano Louvre = 1020mm/40.16in max
<b>PCB Cut-point</b>	83.3mm increment/2000mm max* (3.28in increment/78.74in max*) *Nano Louvre = 1000mm/39.37in max
<b>LED Pitch</b>	13.9mm-72LED/m (0.55in - 22LED/ft)
<b>Chip</b>	RGB
<b>Cover/Optics</b>	Clear (100°)/Diffused (95°)/KKLN-01 Lens (14°)/ KKLN-03 Lens (23°)/Diffused + Nano Louvre (35°)
<b>CCT</b>	Red 620-625nm/Blue 455-460nm/Green 520-525nm
<b>LED binning</b>	5nm tolerance
<b>CRI</b>	N/A
<b>Lifetime</b>	50,000 hours @ 25°C (50,000 hours @ 77°F)
<b>Operating temp</b>	T <sub>a</sub> = -20 to 60°C (T <sub>c</sub> max = 70°C) T <sub>a</sub> = -4 to 140°F (T <sub>c</sub> max = 158°F)
<b>IP Rating</b>	IP44/67
<b>Finish</b>	Silver anodised
<b>Mounting</b>	Surface mounting via clips or brackets
<b>Power feed</b>	Sheathed hardwire tails or male/female connectors
<b>Control</b>	DMX/DALI



Power consumption	Supply voltage	Supply current
15.6W/m (4.75W/ft)	24V DC	0.65A/m (0.20A/ft)

Clear	Clear + KKLN-01 (14°)	Clear + KKLN-03 (23°)	Diffused Cover	Diffused + Nano Louvre
Red: 114lm/m (35lm/ft) Green: 244lm/m (74lm/ft) Blue: 38lm/m (12lm/ft) RGB: 350lm/m (107lm/ft)	Red: 55lm/m (17lm/ft) Green: 116lm/m (35lm/ft) Blue: 18lm/m (6lm/ft) RGB: 167lm/m (51lm/ft)	Red: 55lm/m (17lm/ft) Green: 116lm/m (35lm/ft) Blue: 19lm/m (6lm/ft) RGB: 177lm/m (54lm/ft)	Red: 66lm/m (18lm/ft) Green: 129lm/m (39lm/ft) Blue: 20lm/m (6lm/ft) RGB: 186lm/m (57lm/ft)	Red: 25lm/m (8lm/ft) Green: 54lm/m (16lm/ft) Blue: 8lm/m (3lm/ft) RGB: 78lm/m (24lm/ft)

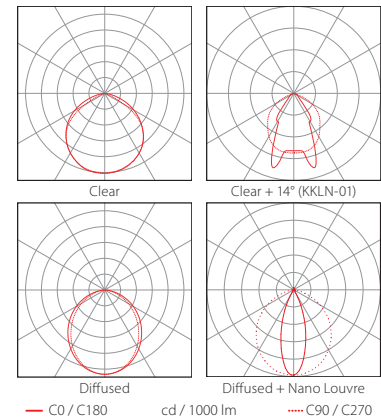
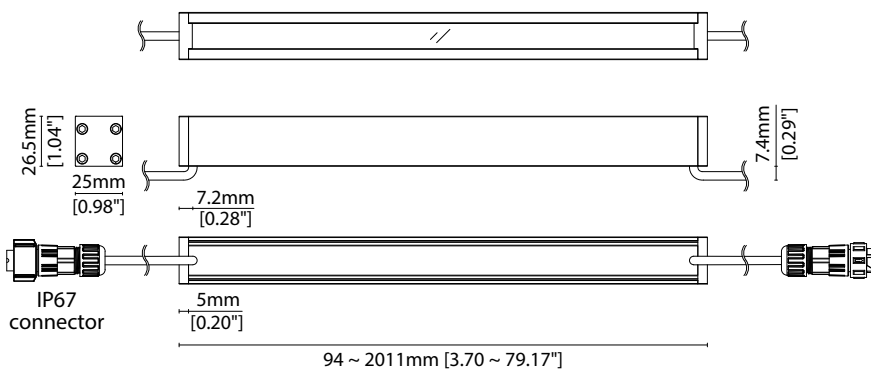

Data derived from production samples tested to UKAS/IESNA LM-79-08 standards.

See KKDC website for product document updates.

[www.kkdc.lighting](http://www.kkdc.lighting)

MOMORGBS-03.04EN-20240520

### FIXTURE

Model	Finish	Cover/Lens <sup>1</sup>	Grade	LED	Colour (CCT)	Length Availability <sup>2</sup>	IP	Cable Length	Power Feed <sup>3</sup>	Input
MOMO	MM Silver Anodised	SA Clear Clear + KKLN-01 (14°) Clear + KKLN-03 (23°) Diffused Diffused + Nano Louvre <sup>4,5</sup>	B P A C CN	s 501 501	RGB RGB	m 94-2011mm 41.7mm increments  i 3.70-79.53in 1.64in increments  (Specify length code OR total run length)	IP44 44 IP67 <sup>6</sup> 67	300mm/ 11.81" 0300	Single ø4.3mm sheath tail S00A  Double ø4.3mm sheath tail D00A  Single ø4.3mm sheath IP67 Male connector S67A  Double ø4.3mm sheath IP67 connector D67A	DC 24V g

<sup>1</sup> Refer to **Cover/Lens Options** on **Options** pages      <sup>2</sup> Refer to **Length Availability List** or enter total run length instead of length code      <sup>3</sup> Refer to **Power Feed Options** on **Options** pages  
<sup>4</sup> Max length available with Nano Louvre is 1020mm  
<sup>5</sup> Nano Louvre suitable for IP44 variant ONLY. Prolonged exposure to water droplets on cover surface may result in superficial peeling of Nano louvre film without affecting integrity of housing ingress  
<sup>6</sup> Due to the clear, flush potted polyurethane top layer on IP67 MOMO a colour shift of +/-20K should be expected

### Code Example:

MM	-	SA	-	C	-	s	-	501	-	RGB	-	m	520	-	67	-	0300	-	D67A	-	g
MOMO		Silver Anodised		Diffused				501		RGB			520mm		IP67		300mm/11.81"		Double ø4.3mm sheath IP67 connector		DC 24V

### ACCESSORIES

#### Mounting Accessories

KKCP-03	Clip (1no.)
KKCP-53	Clip (500no.)
KKCP-09	Lock Clip
KKBK-07	Fixing plate
KKBK-21	Adjustable bracket

#### Connection Accessories

CN67-4P-0300	IP67 4 PIN LEDmix male & female 300mm/11.81" pair
CN67-4P-1000	IP67 4 PIN LEDmix male & female 1000mm/39.37" pair
CN67-4P-3000	IP67 4 PIN LEDmix male & female 3000mm/118.11" pair

\* Refer to **Power feed** on **Accessories** pages

#### Exterior Junction Boxes

KKJB-07	IP67 Slim J-Box
KKJB-07R	Potting Resin for IP67 Slim J-Box

\* Refer to **Exterior Junction Boxes** on **Accessories** pages

#### PSU/Driver

0-10V/1-10V/DALI/DMX

\* Refer to **Driver/PSU Options** page for details or provide requirement and KKDC to offer the suitable option

### LED ENGINE VARIANTS (LED STRIP TYPE)

Colour	LED	Lumen/m	Lumen/ft	W/m	W/ft	Spec Doc	Length	Increment
Single CCT	R007	441	135	7	2.13	MOMO R007	103-2020mm (4.05-79.53in)	41.7mm (1.64in)
	R014	904	275	14	4.27	MOMO R014	103-2020mm (4.05-79.53in)	41.7mm (1.64in)
	R020	1280	390	20	6.1	MOMO R020	103-2020mm (4.05-79.53in)	41.7mm (1.64in)
	R030	1813	552	30	9.14	MOMO R030	103-2020mm (4.05-79.53in)	41.7mm (1.64in)
	A040	3960	1207	40	12.19	MOMO A040	97-1520mm (3.82-59.84in)	38.46mm (1.51in)
	Warm Dim/Dynamic White	R207	1004	306	16	4.88	MOMO R207	103-2020mm (4.05-79.53in)
<b>RGB</b>	<b>501</b>	<b>Red 114 Green 244 Blue 38 RGB 350</b>	<b>Red 35 Green 74 Blue 12 RGB 107</b>	<b>15.6</b>	<b>4.75</b>	<b>MOMO RGB</b>	<b>94-2011mm (3.70-79.17in)</b>	<b>41.7mm (1.64in)</b>
RGBW	R201	1263	385	20	6.1	MOMO RGBW	155-2030mm (6.10-79.92in)	62.5mm (2.46in)

\* Performance data: clear cover, RGB

Length Code		Fixture Length <sup>1</sup>		LED Strip <sup>2</sup>		End Cap Dimension <sup>3</sup>		Wattage (W)	Output (lm)			
Metric	Imperial(US)	Metric	Imperial(US)	Metric	Imperial(US)	Metric	Imperial(US)		R	G	B	W
m0103	i0004	103mm	4.07in	83mm	3.28in	10mm	0.39in	1.30	10	21	3	33
m0187	i0007	187mm	7.35in	167mm	6.56in	10mm	0.39in	2.60	21	42	7	66
m0270	i0011	270mm	10.63in	250mm	9.84in	10mm	0.39in	3.90	31	63	10	100
m0353	i0014	353mm	13.91in	333mm	13.12in	10mm	0.39in	5.20	41	84	14	133
m0437	i0017	437mm	17.19in	417mm	16.40in	10mm	0.39in	6.50	52	105	17	166
m0520	i0020	520mm	20.47in	500mm	19.69in	10mm	0.39in	7.80	62	126	21	199
m0603	i0024	603mm	23.75in	583mm	22.97in	10mm	0.39in	9.10	72	147	24	232
m0687	i0027	687mm	27.03in	667mm	26.25in	10mm	0.39in	10.40	83	168	27	265
m0770	i0030	770mm	30.31in	750mm	29.53in	10mm	0.39in	11.70	93	189	31	299
m0853	i0034	853mm	33.60in	833mm	32.81in	10mm	0.39in	13.00	103	210	34	332
m0937	i0037	937mm	36.88in	917mm	36.09in	10mm	0.39in	14.30	114	231	38	365
m1020	i0040	1020mm	40.16in	1000mm	39.37in	10mm	0.39in	15.60	124	252	41	398
m1103	i0043	1103mm	43.44in	1083mm	42.65in	10mm	0.39in	16.90	134	273	44	431
m1187	i0047	1187mm	46.72in	1167mm	45.93in	10mm	0.39in	18.20	145	294	48	464
m1270	i0050	1270mm	50.00in	1250mm	49.21in	10mm	0.39in	19.50	155	315	51	498
m1353	i0053	1353mm	53.28in	1333mm	52.49in	10mm	0.39in	20.80	165	336	55	531
m1437	i0057	1437mm	56.56in	1417mm	55.77in	10mm	0.39in	22.10	176	357	58	564
m1520	i0060	1520mm	59.84in	1500mm	59.06in	10mm	0.39in	23.40	186	378	62	597
m1603	i0063	1603mm	63.12in	1583mm	62.34in	10mm	0.39in	24.70	196	399	65	630
m1687	i0066	1687mm	66.40in	1667mm	65.62in	10mm	0.39in	26.00	207	420	68	663
m1770	i0070	1770mm	69.69in	1750mm	68.90in	10mm	0.39in	27.30	217	441	72	697
m1853	i0073	1853mm	72.97in	1833mm	72.18in	10mm	0.39in	28.60	227	462	75	730
m1937	i0076	1937mm	76.25in	1917mm	75.46in	10mm	0.39in	29.90	238	483	79	763
m2020	i0080	2020mm	79.53in	2000mm	78.74in	10mm	0.39in	31.20	248	504	82	796

<sup>1</sup> Actual total overall length of light fixture (LED strip + end caps + void/wire hole)

<sup>2</sup> Actual length of PCB strip

<sup>3</sup> Actual length of 2x end caps

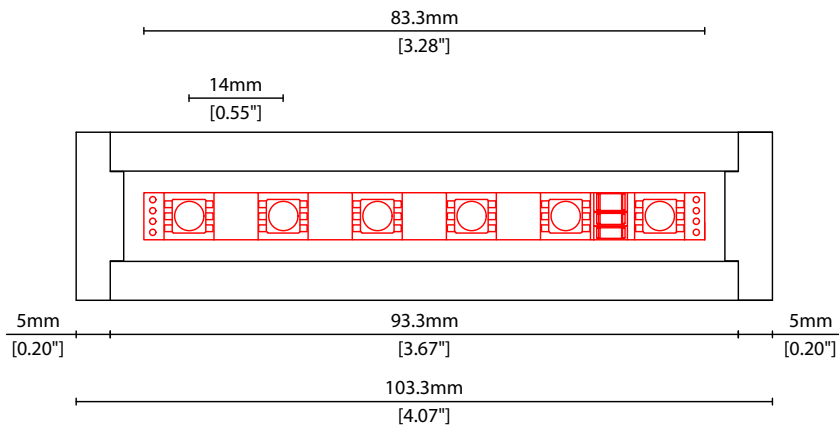

## COVER/LENS OPTIONS

\* Options are an integral part of the fixture ordering codes. Please refer to **Code Table** pages.

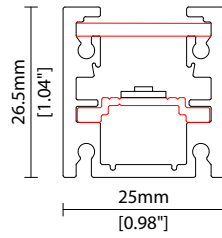

**B** Clear Cover  
W25.0/H26.5mm (W0.98/H1.04")

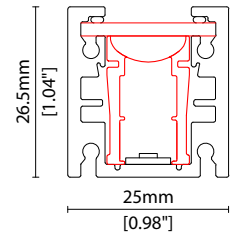

**P** Clear Cover +  
KKLN-01 (14°) lens  
W25.0/H26.5mm (W0.98/H1.04")

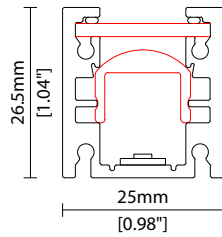

**A** Clear Cover +  
KKLN-03 (23°) lens  
W25.0/H26.5mm (W0.98/H1.04")

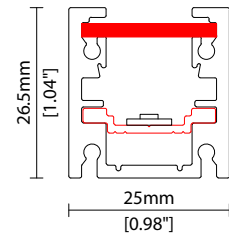

**C** Diffused Cover  
W25.0/H26.5mm (W0.98/H1.04")

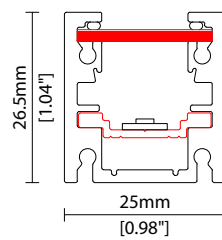

**CN** Diffused Cover + Nano Louvre  
W25.0/H26.5mm (W0.98/H1.04")

## POWER FEED OPTIONS

0300 S00A 300mm (11.81") Single Ø4.3mm sheath tail

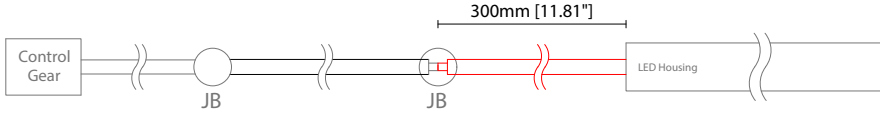

0300 D00A 300mm (11.81") Double Ø4.3mm sheath tail

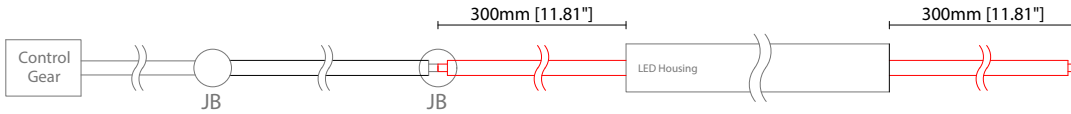

0300 S67A 300mm (11.81") Single Ø4.3mm sheath IP67 connector

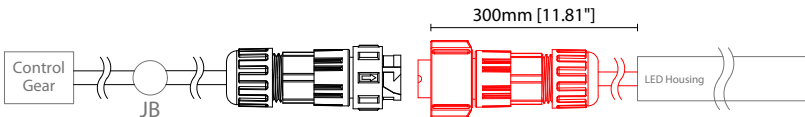

0300 D67A 300mm (11.81") Double Ø4.3mm sheath IP67 connector

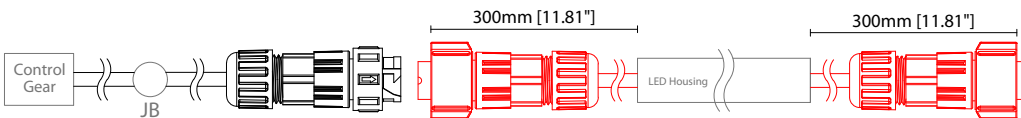

## IP67 4 Pin Connector

Female connector  
4 PIN (IP67)

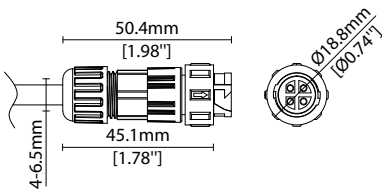

Male connector  
4 PIN (IP67)

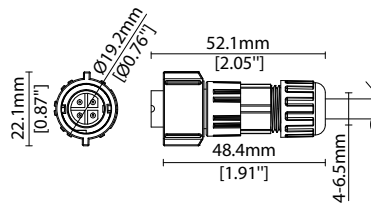

### Key

Control Gear Power supply, sub-controllers & control systems

JB Junction box / cable connection

## MOUNTING ACCESSORIES

Note: Accessories are to be ordered separately with corresponding code shown below.

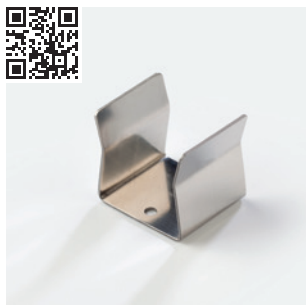

KKCP-03 (1no.)  
KKCP-53 (500no.)

Clip (allow 3 per metre/40in)

S/Steel finish

L25/W33.1/H29.4mm  
(L0.98/W1.3/H1.16")

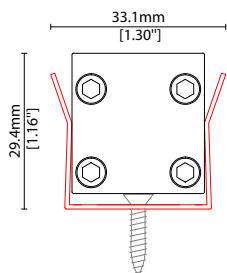

KKCP-09

Lock clip (allow 2 per metre/40in)

S/Steel finish

L25/W26.1/H33mm  
(L0.98/W1.03/H1.3")

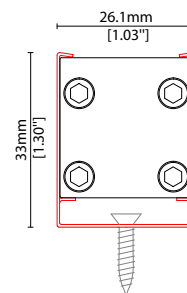

KKBK-07

Fixing plate (allow 2 per metre/40in)

Anodised aluminium finish

L50/W25/H34mm  
(L1.97/W0.98/H1.34")

Pre-assembled in factory

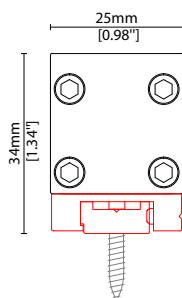

KKBK-21

Adjustable bracket  
(allow 2 per metre/40in)

Anodised aluminium finish

L34/W25/H37.8mm  
(L1.34/W0.98/H1.49")

Pre-assembled in factory

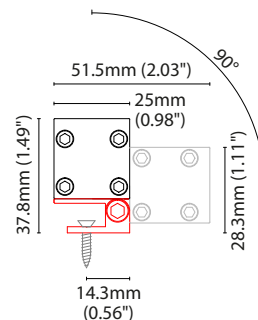

## POWER FEED

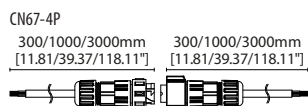

CN67-4P-0300 300mm (11.81in) pair  
CN67-4P-1000 1000mm (39.37in) pair  
CN67-4P-3000 3000mm (118.11in) pair

IP67

4 PIN male + female (RGB/LEDmix) connector set



## EXTERIOR JUNCTION BOXES



**KKJB-07**

IP67 Slim J-Box  
(including type A,B,C, D bushings)



**KKJB-07R**

Potting resin for IP67 Slim J-Box

## KKDC CONTROL



**KKDM-06** 1-10V

visDIM dimmable sub-controller  
(4 x 8A max @ 12-36V)

IP20  
Plastic housing  
L170/W59/H29mm  
(L6.69/W2.32/H1.14in)



**KKSC-05** DMX

visDIM dimmable sub-controller  
(4 x 5A max @ 12-36V)

IP20  
Plastic housing  
L170/W53.4/H28mm  
(L6.69/W2.10/H1.10in)



**KKDL-02** DALI

visDIM dimmable sub-controller  
(4 x 8A max @ 12-36V)

IP20  
Plastic housing  
L170/W59/H29mm  
(L6.69/W2.32/H1.14in)



**KKDL-03** DALI

visDIM dimmable sub-controller  
(4 x 5A max @ 12-36V)

IP20  
Plastic housing  
L166/W53.4/H23mm  
(L6.54/W2.10/H0.91in)



### AVAILABLE PSU OPTIONS

Control Mode	PSU (Order Code)	Input Voltage AC	Output Voltage DC	Rated Output Current	Rated Power	Dim %	IP Rating
Switched	CEN-60-24	90-295V	24V	2.5A	60W	-	IP67
	HLG-60H-24	90-305V	24V	2.5A	60W	-	IP67
	HLG-100H-24	90-305V	24V	4.0A	100W	-	IP67
	HLG-150H-24	90-305V	24V	6.3A	150W	-	IP67
	HLG-240H-24	90-305V	24V	10A	240W	-	IP67
0-10V (1-10V)	PWM-40-24	90-305V	24V	1.67A	40W	100-0.15 (100-10)	IP67
	PWM-60-24	90-305V	24V	2.5A	60W	100-0.15 (100-10)	IP67
	PWM-90-24	90-305V	24V	3.67A	90W	100-0.15 (100-10)	IP67
	PWM-120-24	90-305V	24V	5.0A	120W	100-0.15 (100-10)	IP67
DALI	LIN100A1	120-277V	24V	1A per channel	100W	100-0.1	IP66/IP40
DMX RGB	LIN100A1	120-277V	24V	1.33A per channel	100W	100-0.1	IP66/IP40
DMX RGBW	LIN100A1	120-277A	24V	1A per channel	100W	100-0.1	IP66/IP40

### Flicker Free Options - Combination of PSU+ sub-controller

Control Mode	PSU (Order Code)	Sub-controller (Order Code)	Input Voltage AC	Output Voltage DC	Rated Output Current	Rated Power	Dim %	IP Rating PSU/ Sub-controller
0-10V or 1-10V	CEN-60-24	KKDM-06	90-295V	24V	2.5A	60W	100-0.9	IP67/IP20
	HLG-60H-24	KKDM-06	90-295V	24V	2.5A	60W	100-0.9	IP67/IP20
	HLG-100H-24	KKDM-06	90-295V	24V	4.0A	100W	100-0.9	IP67/IP20
	HLG-150H-24	KKDM-06	90-295V	24V	6.3A	150W	100-0.9	IP67/IP20
	HLG-240H-24	KKDM-06	90-295V	24V	10.0A	240W	100-0.9	IP67/IP20
DALI	CEN-60-24	KKDL-02/03	90-295V	24V	2.5A	60W	100-0.1	IP67/IP20
	HLG-60H-24	KKDL-02/03	90-305V	24V	2.5A	60W	100-0.1	IP67/IP20
	HLG-100H-24	KKDL-02/03	90-305V	24V	4.0A	100W	100-0.1	IP67/IP20
	HLG-150H-24	KKDL-02/03	90-305V	24V	6.3A	150W	100-0.1	IP67/IP20
	HLG-240H-24	KKDL-02/03	90-305V	24V	10.0A	240W	100-0.1	IP67/IP20
DMX RGB	CEN-60-24	KKSC-05	90-295V	24V	2.5A	60W	100-0.9	IP67/IP20
	HLG-60H-24	KKSC-05	90-305V	24V	2.5A	60W	100-0.9	IP67/IP20
	HLG-100H-24	KKSC-05	90-305V	24V	4A	100W	100-0.9	IP67/IP20
	HLG-150H-24	KKSC-05	90-305V	24V	6.3A	150W	100-0.9	IP67/IP20
	HLG-240H-24	KKSC-05	90-305V	24V	10.0A	240W	100-0.9	IP67/IP20

<sup>1</sup> The items shown above cover the most frequently used specification but does not exhaust the possible options

<sup>2</sup> PSU and/or driver can be chosen from the table, or KKDC may recommend the best option upon receipt of the controls requirement and installation environment

<sup>3</sup> Electrical shop drawing will include detailed information of PSU and relevant control drivers

<sup>4</sup> Cut sheets are available on the controls section of [www.kkdc.lighting](http://www.kkdc.lighting) or upon request